



Member of the Phoenix Contact Group

## S H Series M23

Shielded Power Connectors M23  
Circular Hybrid Connectors

# Shielded Power Connectors M23 Series SH

## Technical Data



### Shell material

Machined components: Copper-Zinc alloy (CuZn)  
 die cast components: Zinc (GD-Zn)  
 Shell plating: Nickel (Ni) plated  
 Cable entry: max. 18 mm



### Insulator

Connector inserts: Polyamide (PA66) UL 94 V0

### Contacts

Contact material: Copper-Zinc alloy (CuZn)  
 Contact plating: Nickel (Ni) with gold (Au) passivated  
 Contact termination: crimp type

### Sealing

Sealing rings: Fluor rubber FKM  
 Gaskets: Fluor rubber FKM

All connectors with universal shielding material for different jacket and shield diameters.

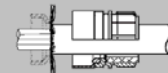

### Temperature

Temperature (long term) Celsius: - 40 °C up to + 130°C  
 Temperature (long term) Fahrenheit: - 40 °F up to + 266 °F

### Mating

Mating cycles: Standard min. 100  
 Female coupling nuts: M23 screw locking/Speedcon  
 Male receptacles: M23 screw locking/Speedcon



### Protection





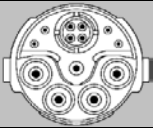
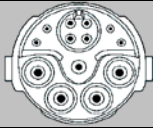





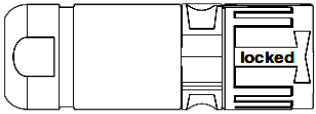

Protection class : IP 67 (mated) depends on which cable gland is used

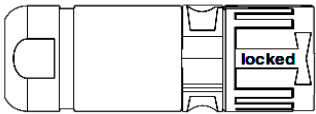
EMC  
shielding

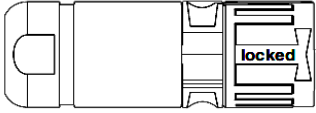
							
Number of positions	13 Pos. (8+4+PE)			13 Pos. (4+4+4+PE)			
Number of contacts	8	4	PE	4	4	4	PE
Contact dia. (mm Ø)	1	2	2	0.8	1	2	2
Rated current at 25° (A)	8	30		3.6	8	30	
Rated voltage (V)	50	630/850		50	50	630/850	
Test voltage (V)	1,500	6,000		1,500	1,500	6,000	
Surge voltage category	III			III			
Wiring size AWG	40-17	24-12	24-12	40-20	40-17	24-12	
Wiring size AWG							

Shielded Power Connectors M23 Series SH  
Shell styles 8, 9, W

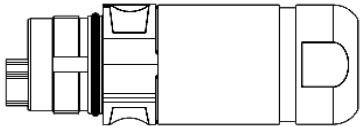

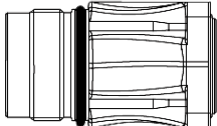
<p><b>SH-8ESC58A8L</b> page C-T-04</p>	<p><b>SH-8ESS48A8L</b> page C-T-05</p>	<p><b>SH-8EPC58A8L</b> page C-T-06</p>
<p>Cable connector, straight with female coupling nut cable entry max. 18 mm female contacts + CAT</p>	<p>Cable connector, straight with female coupling nut cable entry max. 18 mm female contacts + signal</p>	<p>Cable connector, straight with female coupling nut cable entry max. 18 mm male contacts + CAT</p>
 <p> style 8</p>	 <p> style 8</p>	 <p> style 8</p>
<p><b>SH-8EPS48A8L</b> page C-T-07</p>	<p><b>SH-8ESC58A9L</b> page C-T-08</p>	<p><b>SH-8ESS48A9L</b> page C-T-09</p>
<p>Cable connector, straight with female coupling nut cable entry max. 18 mm male contacts + signal</p>	<p>Cable connector, straight with male thread cable entry max. 18 mm female contacts +CAT</p>	<p>Cable connector, straight with male thread cable entry max. 18 mm female + signal</p>
 <p> style 8</p>	 <p>style 9</p>	 <p>style 9</p>
<p><b>SH-8EPC58A9L</b> page C-T-10</p>	<p><b>SH-8EPS48A9L</b> page C-T-11</p>	<p><b>SH-8ESxxxWA00S</b> page C-T-12</p>
<p>Cable connector, straight with male thread cable entry max. 18 mm male contacts + CAT</p>	<p>Cable connector, straight with male thread cable entry max. 18 mm mal contacts + signal</p>	<p>Panel connector, straight with male thread flat design, axial O-ring square flange 26 mm □</p>
 <p>style 9</p>	 <p>style 9</p>	 <p>style W</p>

Shielded Power Connectors M23 Series SH  
Shell styles W, AC, AD

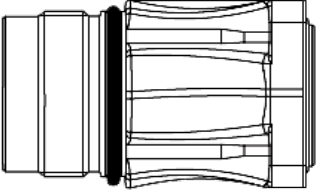
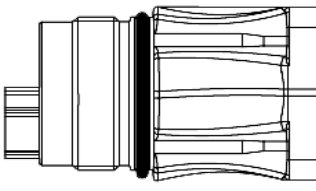
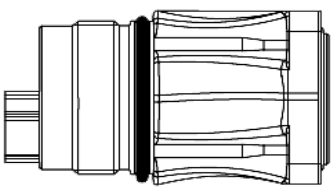
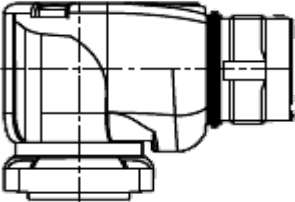
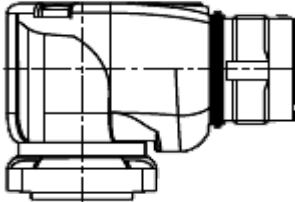
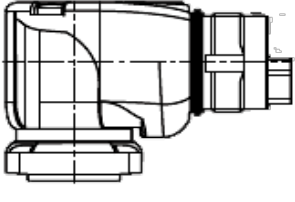
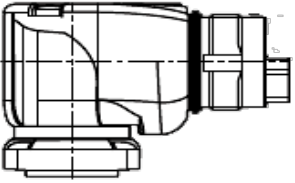

<p><b>SH-8EPxxxxWA00S</b> page C-T-13</p>	<p><b>SH-8EPxxxxWA00S</b> page C-T-14</p>	<p><b>SH-8EPxxxxWA00S</b> page C-T-15</p>
<p>Panel connector, straight with male thread flat design, axial O-ring square flange 26 mm □</p>	<p>Panel connector, straight with male thread flat design, axial O-ring square flange 26 mm □</p>	<p>Panel connector, straight with male thread flat design, axial O-ring square flange 26 mm □</p>
 <p style="text-align: center;">style W</p>	 <p style="text-align: center;">style W</p>	 <p style="text-align: center;">style W</p>
<p><b>SH-8ESxxxxAD/AC</b> page C-T-16</p>	<p><b>SH-8ESxxxxAD/AC</b> page C-T-17</p>	<p><b>SH-8EPxxxxAD/AC</b> page C-T-18</p>
<p>Panel connector, angled with male thread angled design, axial O-ring square flange 26/28 mm □</p>	<p>Panel connector, angled with male thread angled design, axial O-ring square flange 26/28 mm □</p>	<p>Panel connector, angled with male thread angled design, axial O-ring square flange 26/28 mm □</p>
 <p style="text-align: center;">style AD/AC</p>	 <p style="text-align: center;">style AD/AC</p>	 <p style="text-align: center;">style AD/AC</p>
<p><b>SH-8EPxxxxAD/AC</b> page C-T-19</p>		
<p>Panel connector, angled with male thread angled design, axial O-ring square flange 26/28 mm □</p>		
 <p style="text-align: center;">style AD/AC</p>		



Shielded Hybrid Connectors M23 Series SH  
fits all SH Connectors with male thread  
Shell style 8L

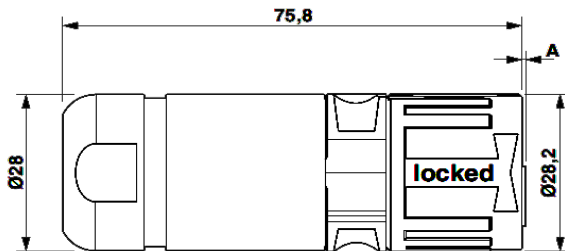

all with integrated strain relief

Caps and accessories: pages B-H-01...  
Mounting tools: pages B-E-01...  
Assembly instructions: page B-D-30  
Crimp tools for contacts: pages B-B-02B  
Crimp contacts: pages B-C-62

We also deliver as a connector set.  
Connector with crimp insert - and  
the contacts are separate included.  
Please ask for P/N



Part Number	SH-	8	E	S	C	5	8	A	8	L	x	x	x	Cable entries.....	
<b>M23 cable connector, hybrid with Speedcon fast locking system</b> 1 PE contact(center) female 2 mm 4 Power contacts female 2 mm 4 Signal contacts female 1 mm 4 Data contacts (CAT) female 0.8 mm															
											<b>D</b>	<b>L</b>	<b>S</b>	7.5 - 18 mm	
												<b>B</b>	<b>4</b>	<b>S</b>	7.5 - 9 mm
												<b>B</b>	<b>3</b>	<b>S</b>	9 - 12 mm
												<b>B</b>	<b>2</b>	<b>S</b>	12 - 15 mm
												<b>B</b>	<b>1</b>	<b>S</b>	15 - 18 mm

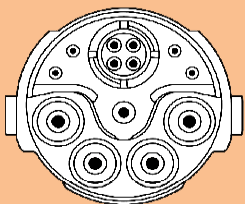



Shielded Hybrid Connectors M23 Series SH  
 fits all SH Connectors with male thread  
 Shell style 8L

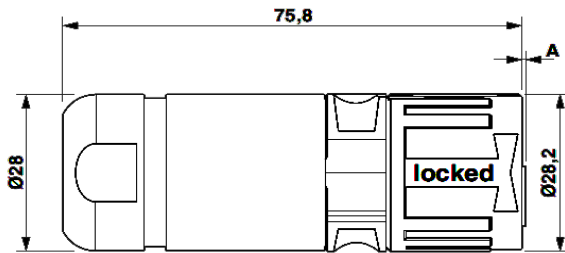

all with integrated strain relief

Caps and accessories: pages B-H-01...  
 Mounting tools: pages B-E-01...  
 Assembly instructions: page B-D-30  
 Crimp tools for contacts: pages B-B-02B  
 Crimp contacts: pages B-C-62

We also deliver as a connector set.  
 Connector with crimp insert - and  
 the contacts are separate included.  
 Please ask for P/N



Part Number	SH-	8	E	S	S	4	8	A	8	L	x	x	x	Cable entries.....	
<b>M23 cable connector, hybrid with            Speedcon fast locking system</b> 1 PE contact(center) female 2 mm 4 Power contacts female 2 mm 8 Signal contacts female 1 mm															
											<b>D</b>	<b>L</b>	<b>S</b>	7.5 - 18 mm	
												<b>B</b>	<b>4</b>	<b>S</b>	7.5 - 9 mm
												<b>B</b>	<b>3</b>	<b>S</b>	9 - 12 mm
												<b>B</b>	<b>2</b>	<b>S</b>	12 - 15 mm
												<b>B</b>	<b>1</b>	<b>S</b>	15 - 18 mm

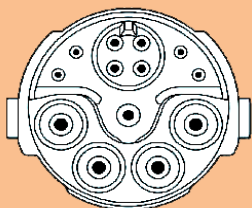



Shielded Hybrid Connectors M23 Series SH  
fits all SH Connectors with male thread  
Shell style 8L

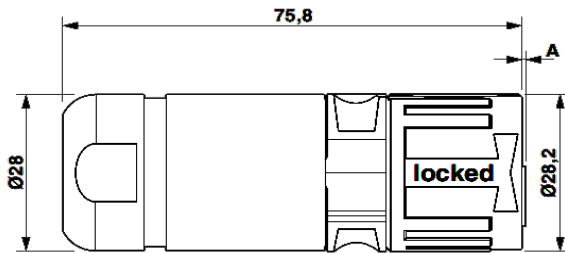

all with integrated strain relief

Caps and accessories: pages B-H-01...  
Mounting tools: pages B-E-01...  
Assembly instructions: page B-D-30  
Crimp tools for contacts: pages B-B-02B  
Crimp contacts: pages B-C-62

We also deliver as a connector set.  
Connector with crimp insert - and  
the contacts are separate included.  
Please ask for P/N



Part Number	SH-	8	E	P	C	5	8	A	8	L	x	x	x	Cable entries.....	
<b>M23 cable connector, hybrid with Speedcon fast locking system</b> 1 PE contact (center)    male    2 mm 4 Power contacts        male    2 mm 4 Signal contacts        male    1 mm 4 Data contacts (CAT)    male    0.8 mm															
											<b>D</b>	<b>L</b>	<b>S</b>	7.5 - 18 mm	
												<b>B</b>	<b>4</b>	<b>S</b>	7.5 - 9 mm
												<b>B</b>	<b>3</b>	<b>S</b>	9 - 12 mm
												<b>B</b>	<b>2</b>	<b>S</b>	12 - 15 mm
												<b>B</b>	<b>1</b>	<b>S</b>	15 - 18 mm

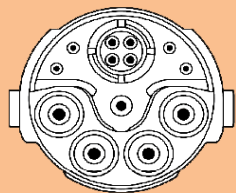



Shielded Hybrid Connectors M23 Series SH  
 fits all SH Connectors with male thread  
 Shell style 8L

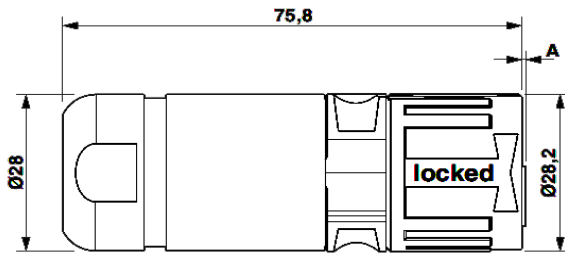

all with integrated strain relief

Caps and accessories: pages B-H-01...  
 Mounting tools: pages B-E-01...  
 Assembly instructions: page B-D-30  
 Crimp tools for contacts: pages B-B-02B  
 Crimp contacts: pages B-C-62

We also deliver as a connector set.  
 Connector with crimp insert - and  
 the contacts are separate included.  
 Please ask for P/N



Part Number	SH-	8	E	P	S	4	8	A	8	L	x	x	x	Cable entries.....	
<b>M23 cable connector, hybrid with            Speedcon fast locking system</b> 1 PE contact (center)    male    2 mm 4 Power contacts        male    2 mm 8 Signal contacts        male    1 mm															
											<b>D</b>	<b>L</b>	<b>S</b>	7.5 - 18 mm	
												<b>B</b>	<b>4</b>	<b>S</b>	7.5 - 9 mm
												<b>B</b>	<b>3</b>	<b>S</b>	9 - 12 mm
												<b>B</b>	<b>2</b>	<b>S</b>	12 - 15 mm
												<b>B</b>	<b>1</b>	<b>S</b>	15 - 18 mm

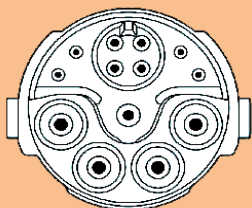





Shielded Hybrid Connectors M23 Series SH  
 fits all SH Connectors with female coupling nut  
 Shell style 9L

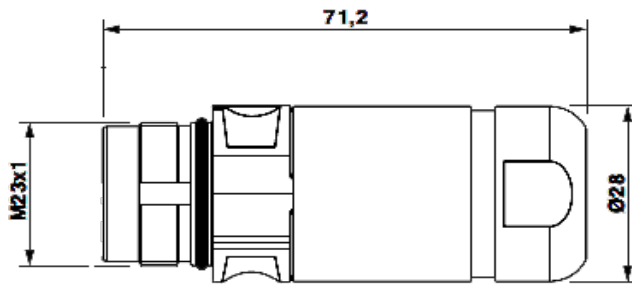

all with integrated strain relief

Caps and accessories: pages B-H-01...  
 Mounting tools: pages B-E-01...  
 Assembly instructions: page B-D-30  
 Crimp tools for contacts: pages B-B-02B  
 Crimp contacts: pages B-C-62

We also deliver as a connector set.  
 Connector with crimp insert - and  
 the contacts are separate included.  
 Please ask for P/N



Part Number	SH-	8	E	S	C	5	8	A	9	L	x	x	x	Cable entries.....
<b>M23 cable connector, hybrid</b>														
		<b>D</b>	<b>L</b>	<b>S</b>										7.5 - 18 mm
		<b>B</b>	<b>4</b>	<b>S</b>										7.5 - 9 mm
	1 PE contact (center)	female	2 mm											
	4 Power contacts	female	2 mm								<b>B</b>	<b>3</b>	<b>S</b>	9 - 12 mm
	4 Signal contacts	female	1 mm											
	4 Data contacts (CAT)	female	0.8 mm								<b>B</b>	<b>2</b>	<b>S</b>	12 - 15 mm
											<b>B</b>	<b>1</b>	<b>S</b>	15 - 18 mm

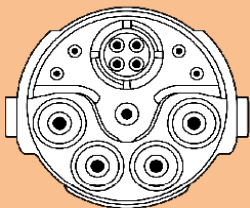



Shielded Hybrid Connectors M23 Series SH  
 fits all SH Connectors with female coupling nut  
 Shell style 9L

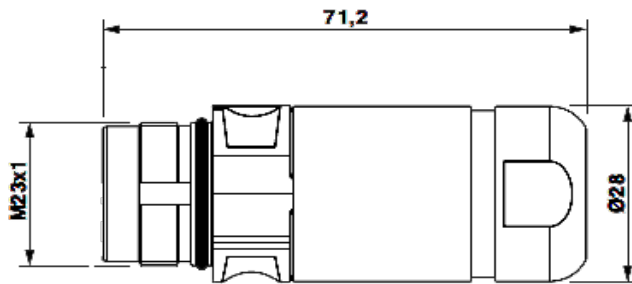

all with integrated strain relief

Caps and accessories: pages B-H-01...  
 Mounting tools: pages B-E-01...  
 Assembly instructions: page B-D-30  
 Crimp tools for contacts: pages B-B-02B  
 Crimp contacts: pages B-C-62

We also deliver as a connector set.  
 Connector with crimp insert - and  
 the contacts are separate included.  
 Please ask for P/N



Part Number	SH-	8	E	S	S	4	8	A	9	L	x	x	x	Cable entries.....	
<b>M23 cable connector, hybrid</b>  1 PE contact (center) female 2 mm 4 Power contacts female 2 mm 8 Signal contacts female 1 mm															
											<b>D</b>	<b>L</b>	<b>S</b>	7.5 - 18 mm	
												<b>B</b>	<b>4</b>	<b>S</b>	7.5 - 9 mm
												<b>B</b>	<b>3</b>	<b>S</b>	9 - 12 mm
												<b>B</b>	<b>2</b>	<b>S</b>	12 - 15 mm
												<b>B</b>	<b>1</b>	<b>S</b>	15 - 18 mm

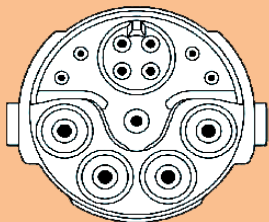



Shielded Hybrid Connectors M23 Series SH  
 fits all SH Connectors with female coupling nut  
 Shell style 9L

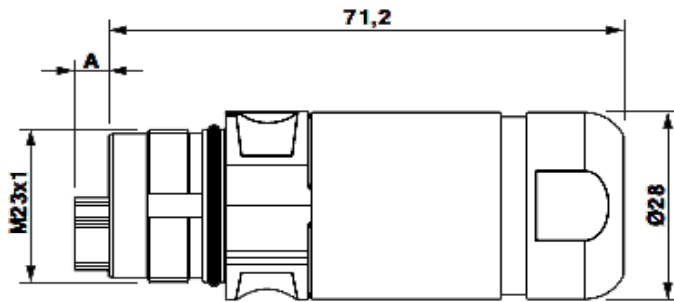

all with integrated strain relief

**Caps and accessories:** pages B-H-01...  
**Mounting tools:** pages B-E-01...  
**Assembly instructions:** page B-D-30  
**Crimp tools for contacts:** pages B-B-02B  
**Crimp contacts:** pages B-C-62

We also deliver as a connector set.  
 Connector with crimp insert - and  
 the contacts are separate included.  
 Please ask for P/N



Part Number	SH-	8	E	P	C	5	8	A	9	L	x	x	x	Cable entries.....
<b>M23 cable connector, hybrid</b>														
		<b>D</b>	<b>L</b>	<b>S</b>										7.5 - 18 mm
		<b>B</b>	<b>4</b>	<b>S</b>										7.5 - 9 mm
	1 PE contact (center)	male	2 mm											
	4 Power contacts	male	2 mm								<b>B</b>	<b>3</b>	<b>S</b>	9 - 12 mm
	4 Signal contacts	male	1 mm											
	4 Data contacts (CAT)	male	0.8 mm								<b>B</b>	<b>2</b>	<b>S</b>	12 - 15 mm
											<b>B</b>	<b>1</b>	<b>S</b>	15 - 18 mm

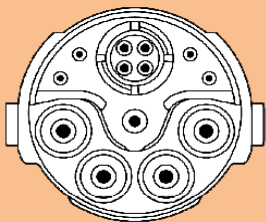



Shielded Hybrid Connectors M23 Series SH  
 fits all SH Connectors with female coupling nut  
 Shell style 9L

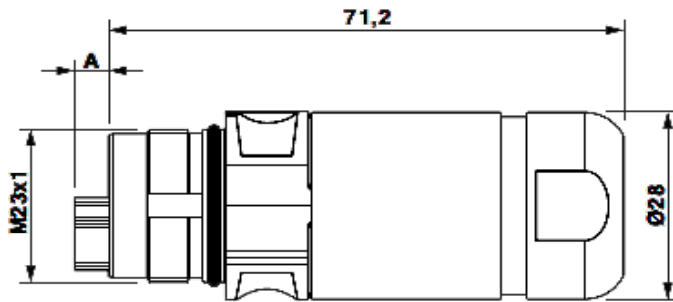

all with integrated strain relief

**Caps and accessories:** pages B-H-01...  
**Mounting tools:** pages B-E-01...  
**Assembly instructions:** page B-D-30  
**Crimp tools for contacts:** pages B-B-02B  
**Crimp contacts:** pages B-C-62

We also deliver as a connector set.  
 Connector with crimp insert - and  
 the contacts are separate included.  
 Please ask for P/N



Part Number	SH-	8	E	P	S	4	8	A	9	L	x	x	x	Cable entries.....
<b>M23 cable connector, hybrid</b>														
		<b>D</b>	<b>L</b>	<b>S</b>										7.5 - 18 mm
		<b>B</b>	<b>4</b>	<b>S</b>										7.5 - 9 mm
	1 PE contact (center)	male	2 mm											
	4 Power contacts	male	2 mm											
	8 Signal contacts	male	1 mm											
		<b>B</b>	<b>2</b>	<b>S</b>										12 - 15 mm
	<b>B</b>	<b>1</b>	<b>S</b>										15 - 18 mm	

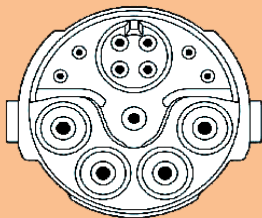



Shielded Hybrid Connectors M23 Series SH  
 fits all SH Connectors with female coupling nut  
 Shell style WA

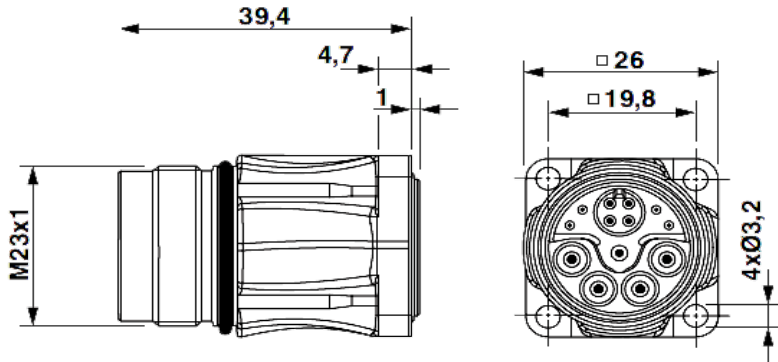

**Caps and accessories:** pages B-H-01...  
**Mounting tools:** pages B-E-01...  
**Assembly instructions:** page n/a  
**Crimp tools for contacts:** pages B-B-02B  
**Crimp contacts:** pages B-C-62

We also deliver as a connector set.  
 Connector with crimp insert - and  
 the contacts are separate included.  
 Please ask for P/N



Part Number	SH-	8	E	S	C	5	8	A	W	A	x	x	x	
<b>M23 cable connector, hybrid          straight with square flange</b>											0 0 S			square flange straight 26 x 26 mm with axial O-ring
											1 PE contact (center) female 2 mm 4 Power contacts female 2 mm 4 Signal contacts female 1 mm 4 Data contacts (CAT) female 0.8 mm			

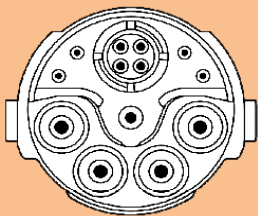



Shielded Hybrid Connectors M23 Series SH  
 fits all SH Connectors with female coupling nut  
 Shell style WA

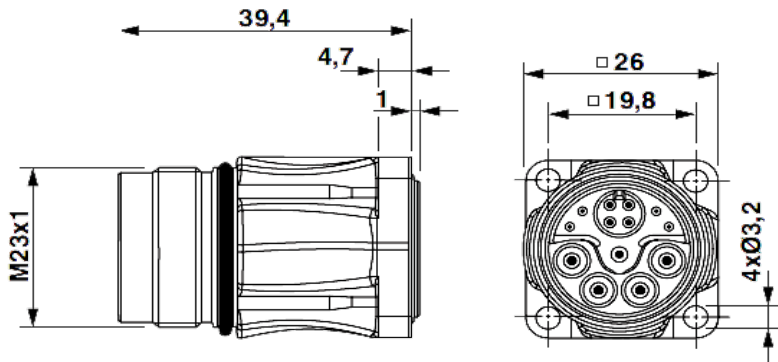

**Caps and accessories:** pages B-H-01...  
**Mounting tools:** pages B-E-01...  
**Assembly instructions:** page n/a  
**Crimp tools for contacts:** pages B-B-02B  
**Crimp contacts:** pages B-C-62

We also deliver as a connector set.  
 Connector with crimp insert - and  
 the contacts are separate included.  
 Please ask for P/N



Part Number	SH-	8	E	S	S	4	8	A	W	A	x	x	x	
<b>M23 cable connector, hybrid            straight with square flange</b> 1 PE contact (center) female 2 mm 4 Power contacts female 2 mm 8 Signal contacts female 1 mm														
														0 0 S

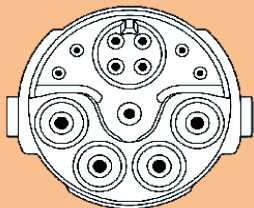



Shielded Hybrid Connectors M23 Series SH  
 fits all SH Connectors with female coupling nut  
 Shell style WA

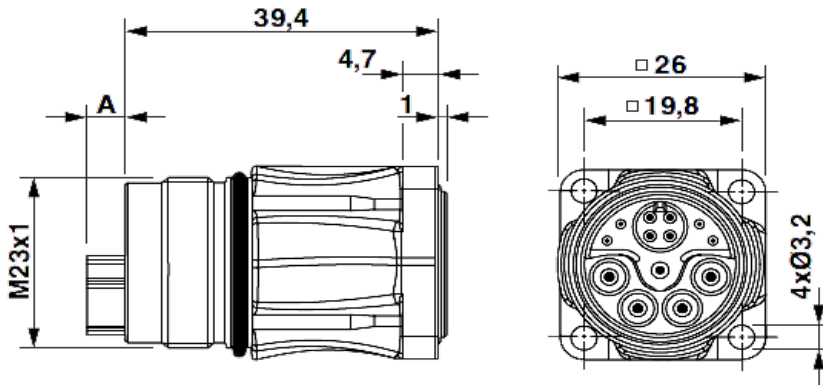

Caps and accessories: pages B-H-01...  
 Mounting tools: pages B-E-01...  
 Assembly instructions: page n/a  
 Crimp tools for contacts: pages B-B-02B  
 Crimp contacts: pages B-C-62

We also deliver as a connector set.  
 Connector with crimp insert - and  
 the contacts are separate included.  
 Please ask for P/N



Part Number	SH-	8	E	P	C	5	8	A	W	A	x	x	x	
<b>M23 cable connector, hybrid          straight with square flange</b> 1 PE contact (center)    male    2 mm 4 Power contacts        male    2 mm 4 Signal contacts        male    1 mm 4 Data contacts (CAT)    male    0.8 mm														
														0 0 S
														square flange straight 26 x 26 mm with axial O-ring

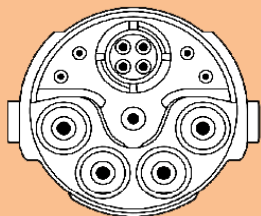



Shielded Hybrid Connectors M23 Series SH  
 fits all SH Connectors with female coupling nut  
 Shell style WA

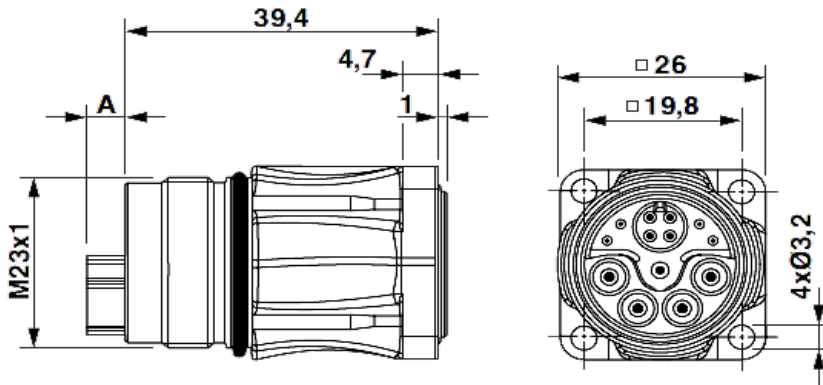

Caps and accessories: pages B-H-01...  
 Mounting tools: pages B-E-01...  
 Assembly instructions: page n/a  
 Crimp tools for contacts: pages B-B-02B  
 Crimp contacts: pages B-C-62

We also deliver as a connector set.  
 Connector with crimp insert - and  
 the contacts are separate included.  
 Please ask for P/N



Part Number	SH-	8	E	P	S	4	8	A	W	A	x	x	x		
M23 cable connector, hybrid straight with square flange												0	0	S	square flange straight 26 x 26 mm with axial O-ring
	1 PE contact (center)	male	2 mm												
	4 Power contacts	male	2 mm												
8 Signal contacts	male	1 mm													

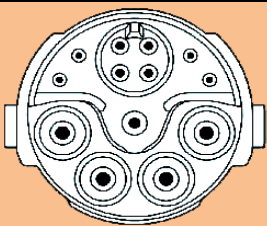





Shielded Hybrid Connectors M23 Series SH  
fits all SH Connectors with female coupling nut  
Shell style AC/AD

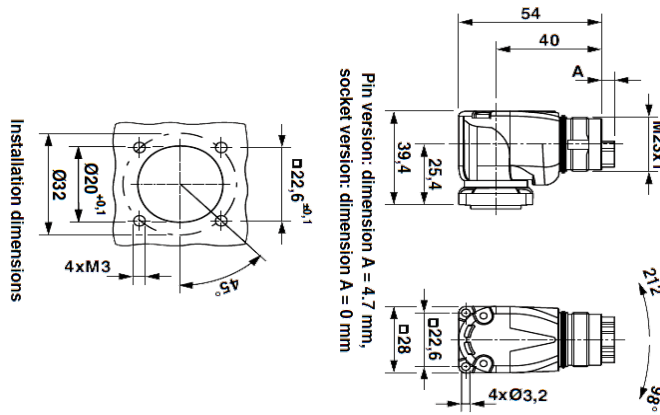

**Caps and accessories:** pages B-H-01...  
**Mounting tools:** pages B-E-01...  
**Assembly instructions:** page n/a  
**Crimp tools for contacts:** pages B-B-02B  
**Crimp contacts:** pages B-C-62

We also deliver as a connector set.  
 Connector with crimp insert - and  
 the contacts are separate included.  
 Please ask for P/N

Part Number	SH-	8	E	S	C	5	8	A	x	x	x	x	x	
<b>M23 cable connector, hybrid            angled with square flange</b> 1 PE contact (center) female 2 mm 4 Power contacts female 2 mm 4 Signal contacts female 1 mm 4 Data contacts (CAT) female 0.8 mm									A	D	0	0	S	square flange angled 26 x 26 mm with axial O-ring
									A	C	0	0	S	square flange angled 28 x 28 mm with axial O-ring

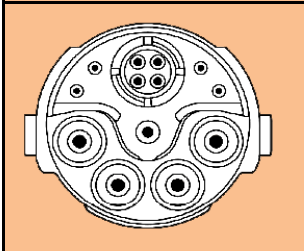



Shielded Hybrid Connectors M23 Series SH  
 fits all SH Connectors with female coupling nut  
 Shell style AC/AD

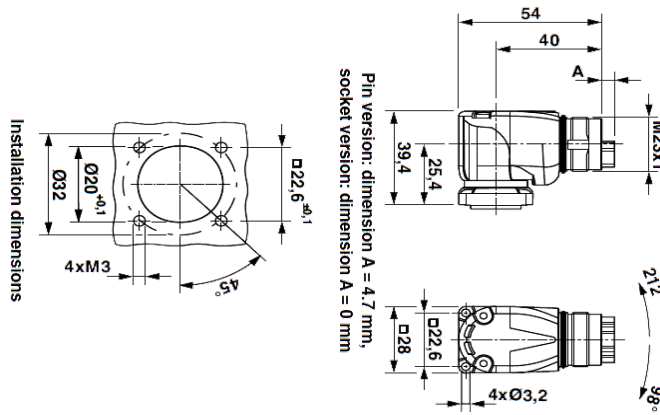

**Caps and accessories:** pages B-H-01...  
**Mounting tools:** pages B-E-01...  
**Assembly instructions:** page n/a  
**Crimp tools for contacts:** pages B-B-02B  
**Crimp contacts:** pages B-C-62

We also deliver as a connector set.  
 Connector with crimp insert - and  
 the contacts are separate included.  
 Please ask for P/N

Part Number	SH-	8	E	S	S	4	8	A	x	x	x	x	x	
<b>M23 cable connector, hybrid            angled with square flange</b> 1 PE contact (center) female 2 mm 4 Power contacts female 2 mm 8 Signal contacts female 1 mm									<b>A</b>	<b>D</b>	<b>0</b>	<b>0</b>	<b>S</b>	square flange angled 26 x 26 mm with axial O-ring
									<b>A</b>	<b>C</b>	<b>0</b>	<b>0</b>	<b>S</b>	square flange angled 28 x 28 mm with axial O-ring

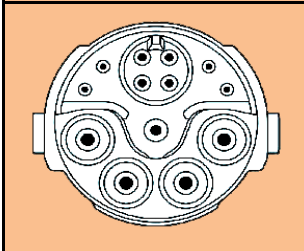



Shielded Hybrid Connectors M23 Series SH  
fits all SH Connectors with female coupling nut  
Shell style AC/AD

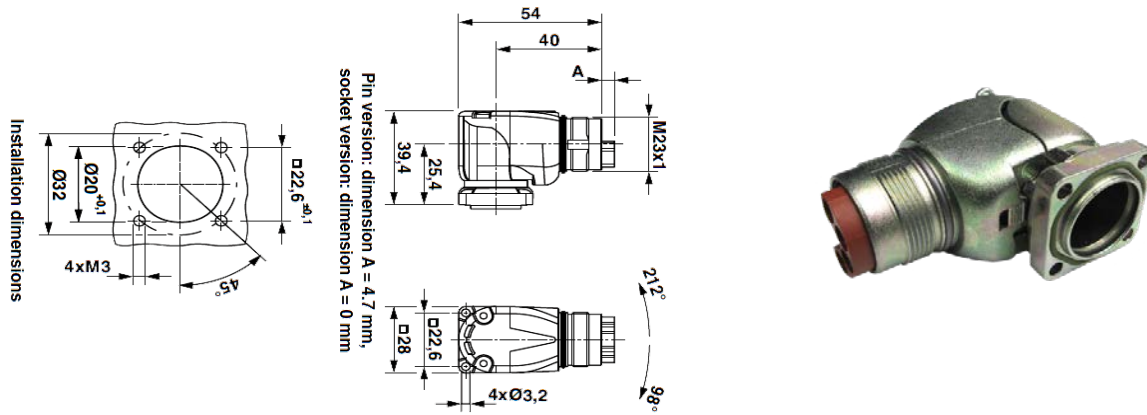

**Caps and accessories:** pages B-H-01...  
**Mounting tools:** pages B-E-01...  
**Assembly instructions:** page n/a  
**Crimp tools for contacts:** pages B-B-02B  
**Crimp contacts:** pages B-C-62

We also deliver as a connector set.  
Connector with crimp insert - and  
the contacts are separate included.  
Please ask for P/N

Part Number	SH-	8	E	P	C	5	8	A	x	x	x	x	x
<b>M23 cable connector, hybrid angled with square flange</b> 1 PE contact (center) male 2 mm 4 Power contacts male 2 mm 4 Signal contacts male 1 mm 4 Data contacts (CAT) male 0.8 mm													
	<b>A D 0 0 S</b> square flange angled 26 x 26 mm with axial O-ring												
<b>A C 0 0 S</b> square flange angled 28 x 28 mm with axial O-ring													

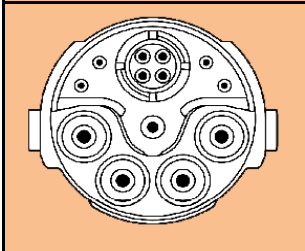



Shielded Hybrid Connectors M23 Series SH  
fits all SH Connectors with female coupling nut  
Shell style AC/AD

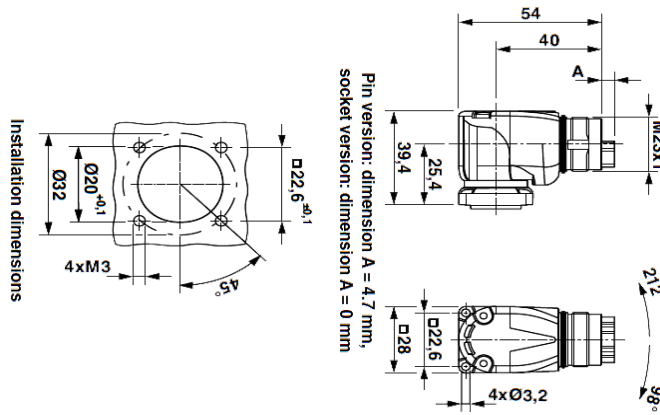

**Caps and accessories:** pages B-H-01...  
**Mounting tools:** pages B-E-01...  
**Assembly instructions:** page n/a  
**Crimp tools for contacts:** pages B-B-02B  
**Crimp contacts:** pages B-C-62

We also deliver as a connector set.  
 Connector with crimp insert - and  
 the contacts are separate included.  
 Please ask for P/N

Part Number	SH-	8	E	P	S	4	8	A	x	x	x	x	x	
<b>M23 cable connector, hybrid angled with square flange</b>									<b>A</b>	<b>D</b>	<b>0</b>	<b>0</b>	<b>S</b>	square flange angled 26 x 26 mm with axial O-ring
	1 PE contact (center)	male	2 mm											
	4 Power contacts	male	2 mm											
	8 Signal contacts	male	1 mm						<b>A</b>	<b>C</b>	<b>0</b>	<b>0</b>	<b>S</b>	square flange angled 28 x 28 mm with axial O-ring

